



SITESCAPES

P.O. Box 22326
Lincoln, NE 68542

PF: 402/421-9464
FX: 402/421-9479

WEBSITE: www.sitescapesonline.com
E-MAIL: info@sitescapesonline.com

TITLE

*DRINK RAIL
TABLE*

PRODUCT NO.

UL6-72.0x20x30-FP-SM

INCH TOLERANCES U.O.S.

FRACTION-- $\pm 1/16"$
ANG----- $\pm 1^\circ$

THE INFORMATION CONTAINED IN THIS DRAWING IS THE SOLE PROPERTY OF SITESCAPES, INC. ANY REPRODUCTION IN PART OR AS A WHOLE WITHOUT THE WRITTEN PERMISSION OF SITESCAPES, INC. IS PROHIBITED.

*Available in powder coat and DuraCoat finishes

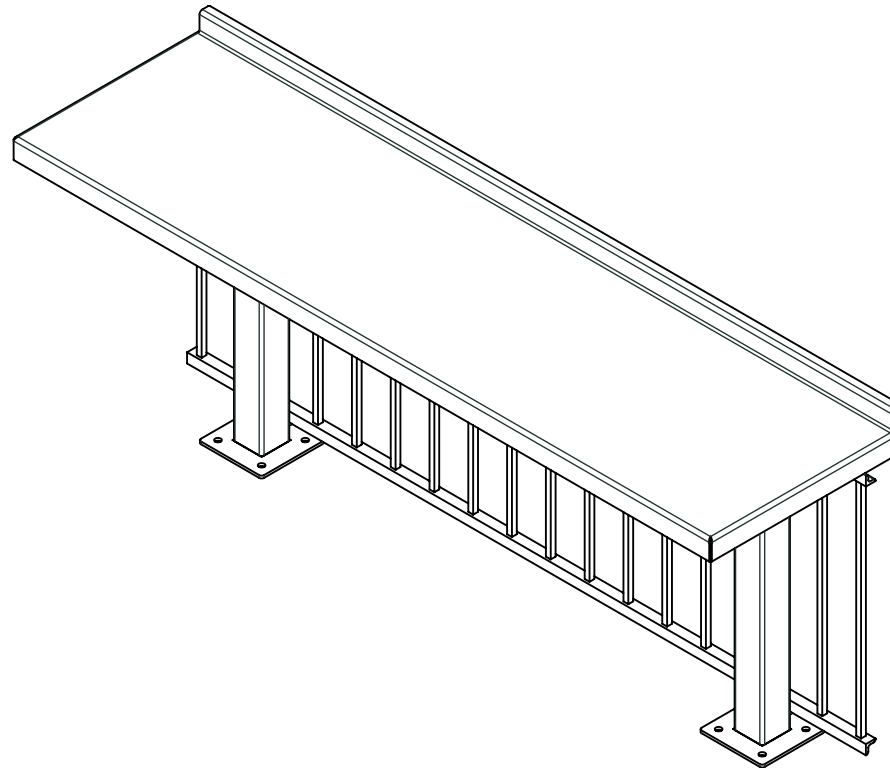



SITESCAPES

P.O. Box 22326
Lincoln, NE 68542

PF: 402/421-9464
FX: 402/421-9479

WEBSITE: www.sitescapesonline.com
E-MAIL: info@sitescapesonline.com

TITLE
**DRINK RAIL
TABLE**

PRODUCT NO.
UL6-72.0x20x30-FP-SM

FRACTION-- $\pm 1/16"$
ANG----- $\pm 1^\circ$

THE INFORMATION CONTAINED IN THIS DRAWING IS THE SOLE PROPERTY OF SITESCAPES, INC. ANY REPRODUCTION IN PART OR AS A WHOLE WITHOUT THE WRITTEN PERMISSION OF SITESCAPES, INC. IS PROHIBITED.

*Available in powder coat and DuraCoat finishes

MATERIALS LIST:

- (1) Table Top - 11 Gauge Stainless Steel
- (2) Upright Tubes - 3" x 1/8" Wall Steel Tubing
- (3) Table Top Supports - 7 Gauge Steel Plate
- (4) Base Plate - 1/4" Stainless Steel Plate with 9/16" Mounting Holes
- (5) Fall Protection Rail - 1" x 1" x 1/4" Steel Angle
- (6) Fall Protection Picket - 1/2" Sq. Steel Bar
- (7) Mounted with Eight $\phi 1/2"$ x 4-5" Stainless Steel Anchor Bolts (Customer Supplied)

